

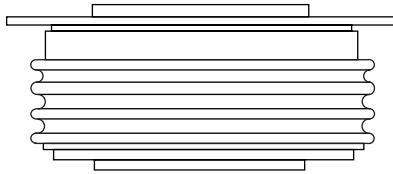

Standard Recovery Diodes (Hockey PUK Version), 1600 A



DO-200AB (B-PUK)

FEATURES

- Wide current range
- High voltage ratings up to 3000 V
- High surge current capabilities
- Diffused junction
- Hockey PUK version
- Case style DO-200AB (B-PUK)
- Lead (Pb)-free



RoHS
COMPLIANT

PRODUCT SUMMARY

$I_{T(AV)}$	1600 A
-------------	--------

TYPICAL APPLICATIONS

- Converters
- Power supplies
- Machine tool controls
- High power drives
- Medium traction applications

MAJOR RATINGS AND CHARACTERISTICS

PARAMETER	TEST CONDITIONS	VALUES	UNITS
$I_{F(AV)}$		1600	A
	T_{hs}	55	°C
$I_{F(RMS)}$		3010	A
	T_{hs}	25	°C
I_{FSM}	50 Hz	16 600	A
	60 Hz	17 400	
I^2t	50 Hz	1386	kA ² s
	60 Hz	1265	
V_{RRM}	Range	400 to 3000	V
T_J		- 40 to 180	°C

ELECTRICAL SPECIFICATIONS

VOLTAGE RATINGS

TYPE NUMBER	VOLTAGE CODE	V_{RRM} , MAXIMUM REPETITIVE PEAK REVERSE VOLTAGE V	V_{RSM} , MAXIMUM NON-REPETITIVE PEAK REVERSE VOLTAGE V	I_{RRM} MAXIMUM AT $T_J = T_J$ MAXIMUM mA
SD1500C..L	04	400	500	50
	08	800	900	
	12	1200	1300	
	16	1600	1700	
	20	2000	2100	
	25	2500	2600	
	30	3000	3100	

SD1500C..L Series



Vishay High Power Products Standard Recovery Diodes
(Hockey PUK Version),
1600 A

FORWARD CONDUCTION					
PARAMETER	SYMBOL	TEST CONDITIONS		VALUES	UNITS
Maximum average forward current at heatsink temperature	$I_{F(AV)}$	180° conduction, half sine wave Double side (single side) cooled		1600 (820)	A
				55 (85)	°C
Maximum RMS forward current	$I_{F(RMS)}$	25 °C heatsink temperature double side cooled		3010	A
Maximum peak, one cycle, non-repetitive surge current	I_{FSM}	t = 10 ms	No voltage reappplied	16 600	
		t = 8.3 ms		17 400	
		t = 10 ms	100% V_{RRM} reappplied	14 000	
		t = 8.3 ms		14 700	
Maximum I^2t for fusing	I^2t	t = 10 ms	No voltage reappplied	1386	kA ² s
		t = 8.3 ms		1265	
		t = 10 ms	100% V_{RRM} reappplied	980	
		t = 8.3 ms		895	
Maximum $I^2\sqrt{t}$ for fusing	$I^2\sqrt{t}$	t = 0.1 to 10 ms, no voltage reappplied		13 860	kA ² /s
Low level value of threshold voltage	$V_{F(TO)1}$	$(16.7\% \times \pi \times I_{F(AV)} < I < \pi \times I_{F(AV)})$, $T_J = T_J$ maximum		0.83	V
High level value of threshold voltage	$V_{F(TO)2}$	$(I > \pi \times I_{F(AV)})$, $T_J = T_J$ maximum		0.95	
Low level value of forward slope resistance	r_{f1}	$(16.7\% \times \pi \times I_{F(AV)} < I < \pi \times I_{F(AV)})$, $T_J = T_J$ maximum		0.27	mΩ
High level value of forward slope resistance	r_{f2}	$(I > \pi \times I_{F(AV)})$, $T_J = T_J$ maximum		0.25	
Maximum forward voltage drop	V_{FM}	$I_{pk} = 3000$ A $T_J = T_J$ maximum, $t_p = 10$ ms sinusoidal wave		1.64	V

THERMAL AND MECHANICAL SPECIFICATIONS					
PARAMETER	SYMBOL	TEST CONDITIONS		VALUES	UNITS
Maximum junction operating temperature range	T_J			- 40 to 180	°C
Maximum storage temperature range	T_{Stg}			- 55 to 200	
Maximum thermal resistance, junction to heatsink	R_{thJ-hs}	DC operation single side cooled		0.073	K/W
		DC operation double side cooled		0.031	
Mounting force, ± 10 %				14 700 (1500)	N (kg)
Approximate weight				255	g
Case style		See dimensions - link at the end of datasheet		DO-200AB (B-PUK)	

ΔR_{thJ-hs} CONDUCTION						
CONDUCTION ANGLE	SINUSOIDAL CONDUCTION		RECTANGULAR CONDUCTION		TEST CONDITIONS	UNITS
	SINGLE SIDE	DOUBLE SIDE	SINGLE SIDE	DOUBLE SIDE		
180°	0.009	0.009	0.006	0.006	$T_J = T_J$ maximum	K/W
120°	0.011	0.011	0.011	0.011		
90°	0.014	0.014	0.015	0.015		
60°	0.020	0.020	0.021	0.021		
30°	0.035	0.035	0.036	0.036		

Note

- The table above shows the increment of thermal resistance R_{thJ-hs} when devices operate at different conduction angles than DC



SD1500C..L Series

Standard Recovery Diodes Vishay High Power Products (Hockey PUK Version), 1600 A

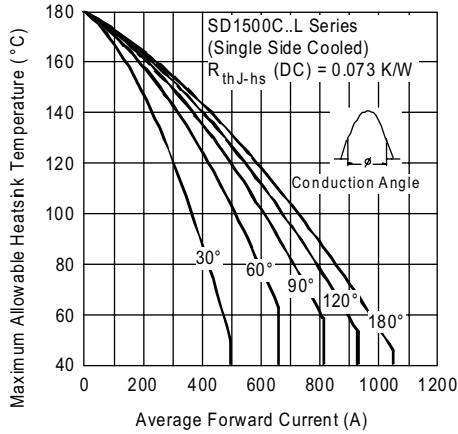

Fig. 1 - Current Ratings Characteristics

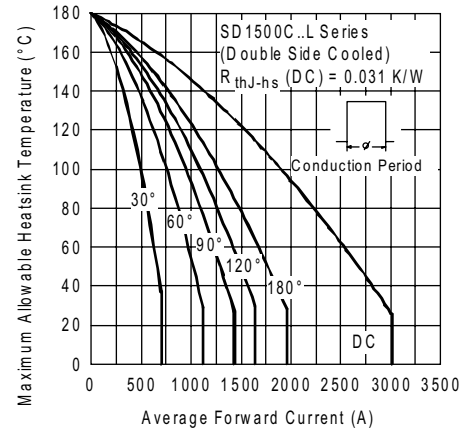

Fig. 4 - Current Ratings Characteristics

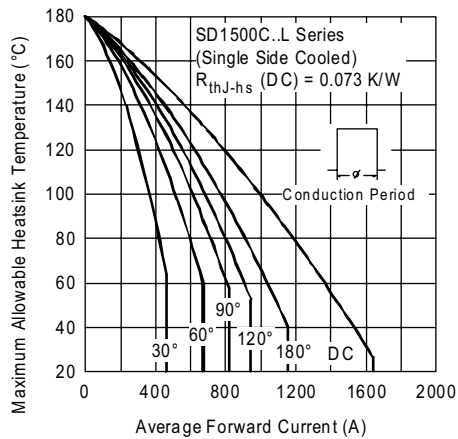

Fig. 2 - Current Ratings Characteristics

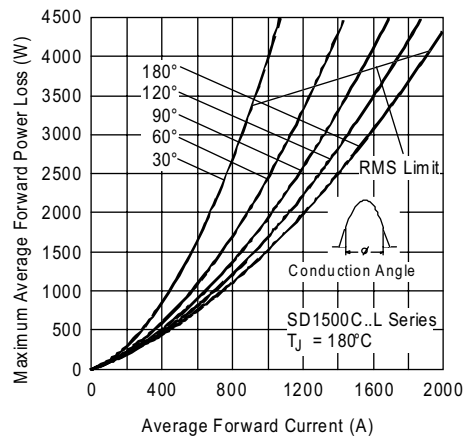

Fig. 5 - Forward Power Loss Characteristics

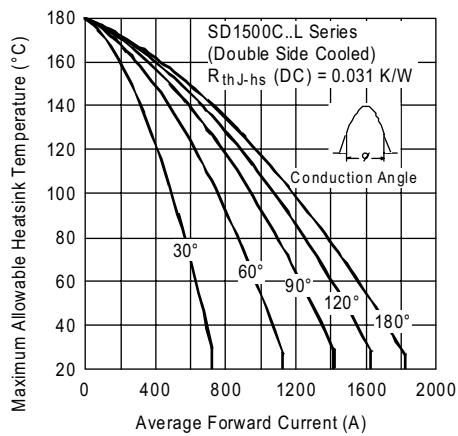

Fig. 3 - Current Ratings Characteristics

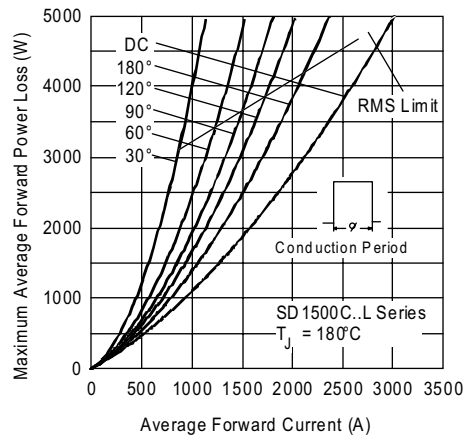

Fig. 6 - Forward Power Loss Characteristics

SD1500C..L Series



Vishay High Power Products Standard Recovery Diodes (Hockey PUK Version), 1600 A

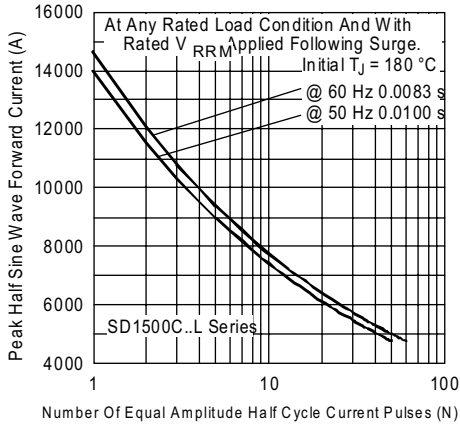

Fig. 7 - Maximum Non-Repetitive Surge Current Single and Double Side Cooled

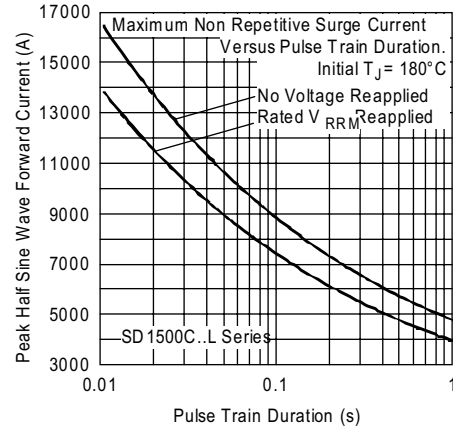

Fig. 8 - Maximum Non-Repetitive Surge Current Single and Double Side Cooled

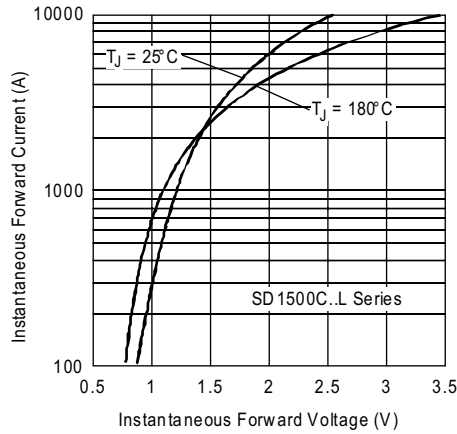

Fig. 9 - Forward Voltage Drop Characteristics

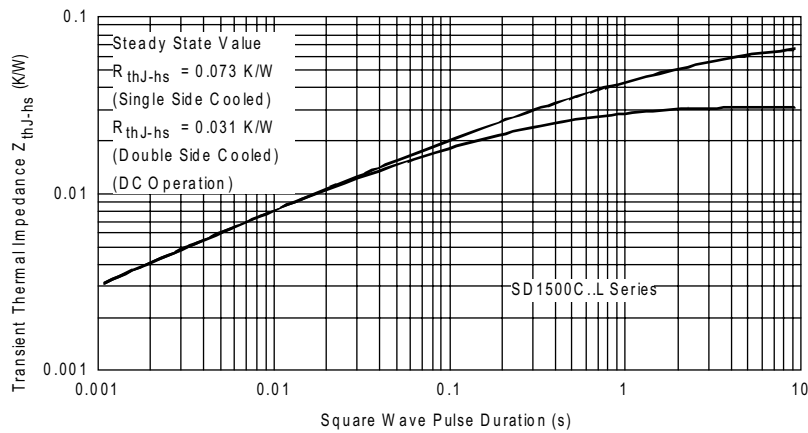

Fig. 10 - Thermal Impedance Z_{thJC} Characteristics



SD1500C..L Series

Standard Recovery Diodes Vishay High Power Products
(Hockey PUK Version),
1600 A

ORDERING INFORMATION TABLE

Device code	SD	150	0	C	30	L
	①	②	③	④	⑤	⑥
1	-	Diode				
2	-	Essential part number				
3	-	0 = Standard recovery				
4	-	C = Ceramic PUK				
5	-	Voltage code x 100 = V_{RRM} (see Voltage Ratings table)				
6	-	L = PUK case DO-200AB (B-PUK)				



DO-200AB (B-PUK)

DIMENSIONS in millimeters (inches)

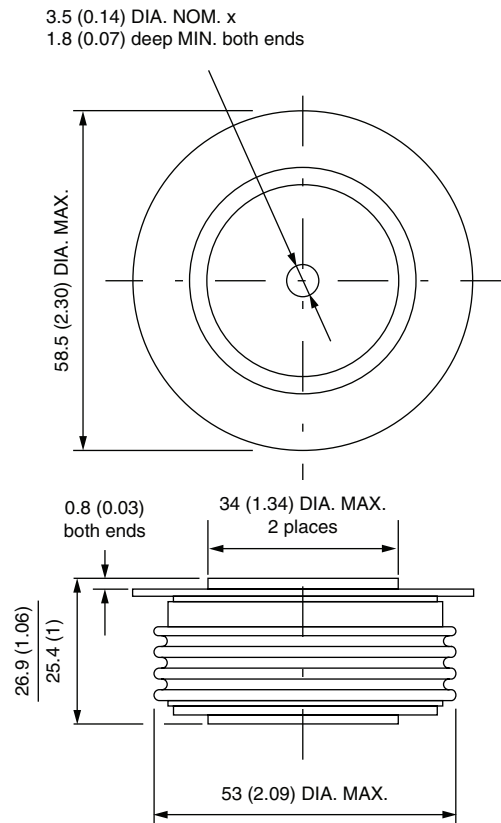

Quote between upper and lower pole pieces has to be considered after application of mounting force (see Thermal and Mechanical Specifications)



Disclaimer

All product specifications and data are subject to change without notice.

Vishay Intertechnology, Inc., its affiliates, agents, and employees, and all persons acting on its or their behalf (collectively, "Vishay"), disclaim any and all liability for any errors, inaccuracies or incompleteness contained herein or in any other disclosure relating to any product.

Vishay disclaims any and all liability arising out of the use or application of any product described herein or of any information provided herein to the maximum extent permitted by law. The product specifications do not expand or otherwise modify Vishay's terms and conditions of purchase, including but not limited to the warranty expressed therein, which apply to these products.

No license, express or implied, by estoppel or otherwise, to any intellectual property rights is granted by this document or by any conduct of Vishay.

The products shown herein are not designed for use in medical, life-saving, or life-sustaining applications unless otherwise expressly indicated. Customers using or selling Vishay products not expressly indicated for use in such applications do so entirely at their own risk and agree to fully indemnify Vishay for any damages arising or resulting from such use or sale. Please contact authorized Vishay personnel to obtain written terms and conditions regarding products designed for such applications.

Product names and markings noted herein may be trademarks of their respective owners.